



Surface Mount Transient Voltage Suppressors

Features

- Surface mount package.
- Excellent clamping capability.
- Glass passivated junction.
- Low Leakage current.
- Meets ISO7637-2 test(varied by test condition)
- Plastic material has UL flammability classification 94V-O
- RoHS compliant in lead-free versions.
- AEC-Q101 qualified.

DO-218AB

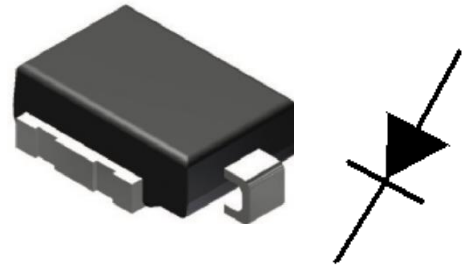

Uni-directional

Application

Ideal for sensitive electronics protection against voltage transients.
Especially for automotive load dump protection.



Bi-directional

Mechanical Characteristics

CASE: DO-218AB Molded Plastic over glass passivated junction.
Polarity: Heatsink is anode for uni-direction.

Maximum Ratings And Characteristics @ 25°C Ambient Temperature (unless otherwise noted)

Parameter	Symbol	Value	Units
Peak Pulse Power dissipation on 10/1000us Waveform (Note 1, FIG.1)	P _{PPM}	6600	W
Power Dissipation on Infinite Heatsink at T _c =25°C (FIG.2)	P _D	8	W
For uni-direction, Peak Forward Surge Current, 8.3ms Single Half Sine-wave Superimposed on Rated Load, (JEDEC Method)(Note 2. 3)	I _{FSM}	700	Amps
Operating Junction Temperature Range	T _J	-55 to 150	°C
Storage Temperature Range	T _{STG}	-55 to 150	°C

Notes:

1. Non-repetitive current pulse, per Fig.1 and derated above T_A=25°C per Fig.2.
2. Mounted on 5.0mm² (0.03mm thick) Copper Pads to each terminal.
3. 8.3 ms single half sine-wave, or equivalent square wave, Duty cycle=4 pluses per minute maximum.

SM8S16A/CA~SM8S100A/CA

Electrical Specification @ Tamb 25°C

Type Number		Reverse Stand-Off Voltage	Breakdown Voltage Min. @I _T	Breakdown Voltage Max. @ I _T	Test Current t	Maximum Clamping Voltage @I _{PP}	Max. Peak Pulse Current	Max. Reverse Leakage @V _{RWM}
(uni)	Bi	V _{RWM} (V)	V _{BR MIN} (V)	V _{BR MAX} (V)	I _T (mA)	V _C (V)	I _{PP} (A)	I _R (uA)
SM8S16A	SM8S16CA	16	17.8	19.7	5.0	26.0	254	10.0
SM8S17A	SM8S17CA	17	18.9	20.9	5.0	27.6	239	10.0
SM8S18A	SM8S18CA	18	20.0	22.1	5.0	29.2	226	10.0
SM8S20A	SM8S20CA	20	22.2	24.5	5.0	32.4	204	10.0
SM8S22A	SM8S22CA	22	24.4	26.9	5.0	35.5	186	10.0
SM8S24A	SM8S24CA	24	26.7	29.5	5.0	38.9	170	10.0
SM8S26A	SM8S26CA	26	28.9	31.9	5.0	42.1	157	10.0
SM8S28A	SM8S28CA	28	31.1	34.4	5.0	45.4	145	10.0
SM8S30A	SM8S30CA	30	33.3	36.8	5.0	48.4	136	10.0
SM8S33A	SM8S33CA	33	36.7	40.6	5.0	53.3	124	10.0
SM8S36A	SM8S36CA	36	40.0	44.2	5.0	58.1	114	10.0
SM8S40A	SM8S40CA	40	44.4	49.1	5.0	64.5	102	10.0
SM8S43A	SM8S43CA	43	47.8	52.8	5.0	69.4	95.1	10.0
SM8S45A	SM8S45CA	45	50.0	55.3	5.0	72.7	90.8	10.0
SM8S48A	SM8S48CA	48	53.3	58.9	5.0	77.4	85.3	10.0
SM8S51A	SM8S51CA	51	56.7	62.7	5.0	82.4	80.1	10.0
SM8S54A	SM8S54CA	54	60.0	66.3	5.0	87.1	75.8	10.0
SM8S58A	SM8S58CA	58	64.4	71.2	5.0	93.6	70.5	10.0
SM8S60A	SM8S60CA	60	66.7	73.7	5.0	96.8	68.1	10.0
SM8S64A	SM8S64CA	64	71.1	78.6	5.0	103	64.1	10.0
SM8S70A	SM8S70CA	70	77.8	86.0	5.0	113	58.4	10.0
SM8S75A	SM8S75CA	75	83.0	92.1	5.0	121	54.5	10.0
SM8S78A	SM8S78CA	78	86.0	95.8	5.0	126	52.4	10.0
SM8S85A	SM8S85CA	85	94.0	104.0	5.0	137	48.2	10.0
SM8S90A	SM8S90CA	90	100.0	111.0	5.0	146	45.2	10.0
SM8S100A	SM8S100CA	100	111.0	123.0	5.0	162	40.7	10.0

SM8S16A/CA~SM8S100A/CA

Ratings and Characteristic Curves $T_A=25^{\circ}\text{C}$ unless otherwise noted

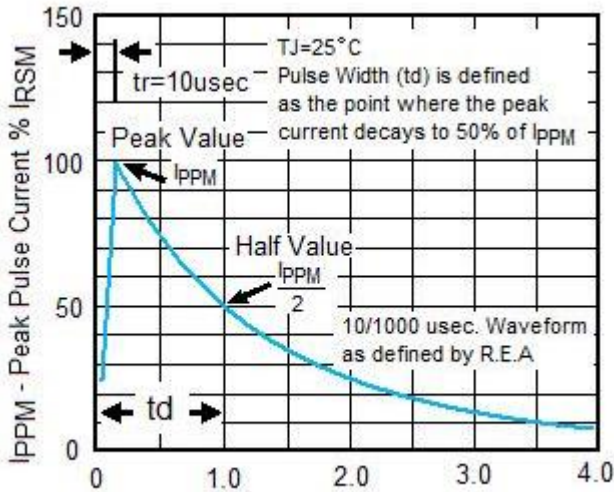

Fig.1 Pulse Waveform

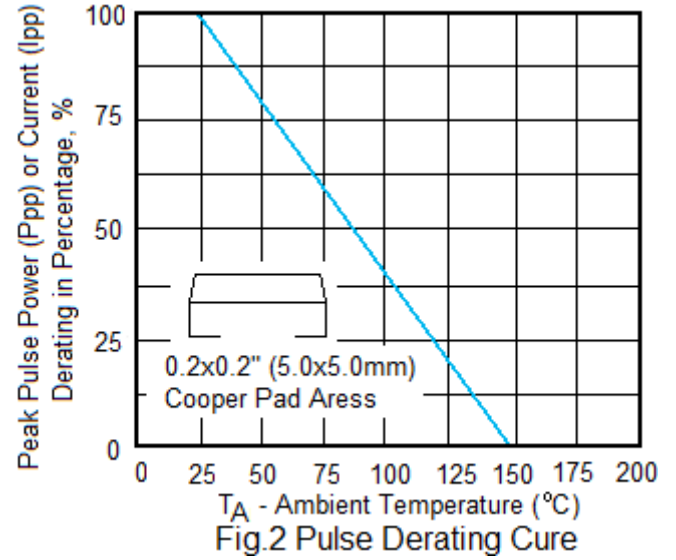

Fig.2 Pulse Derating Curve

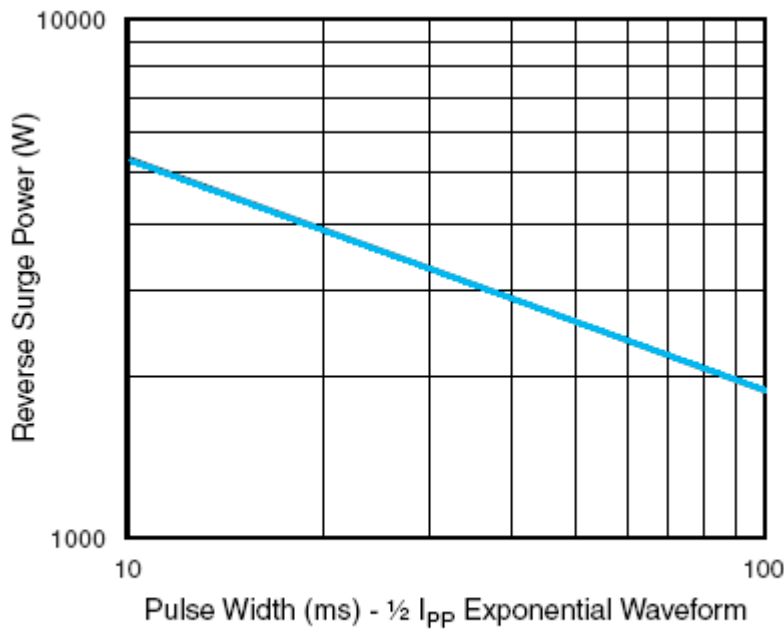
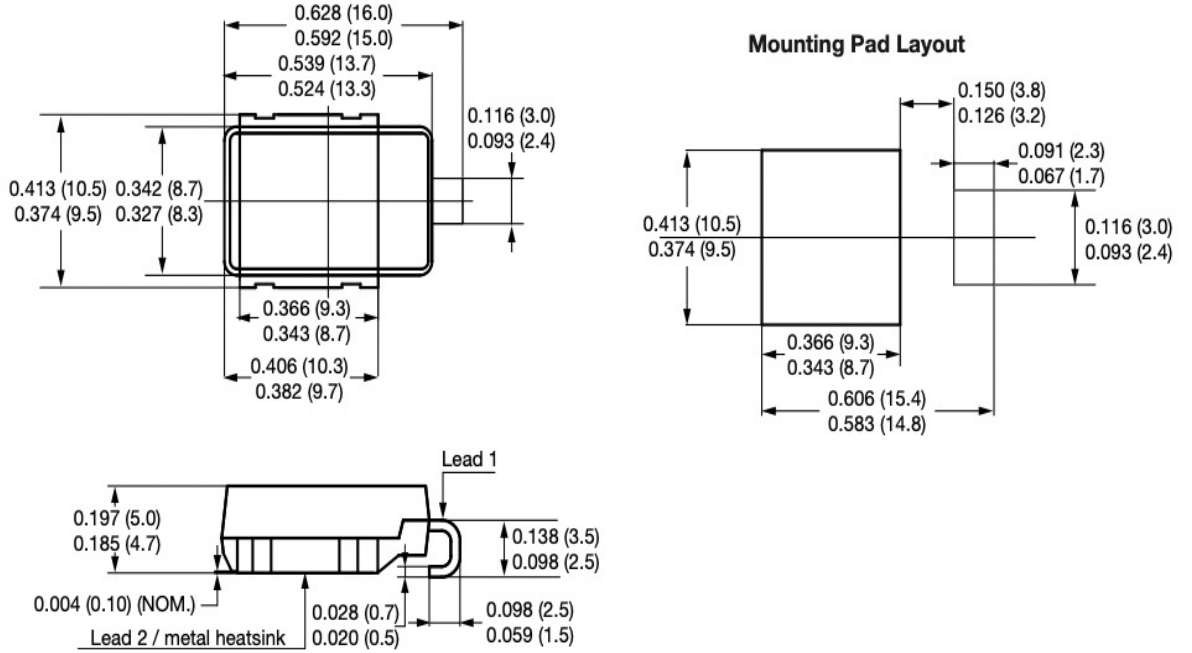

Figure 3. Reverse Power Capability

SM8S16A/CA~SM8S100A/CA

Package Outline Dimensions

DO-218AB



WWW.SEMITECH.CN

SM8S16A/CA~SM8S100A/CA

Reel Dimension

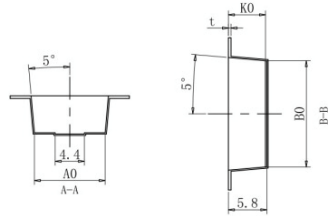
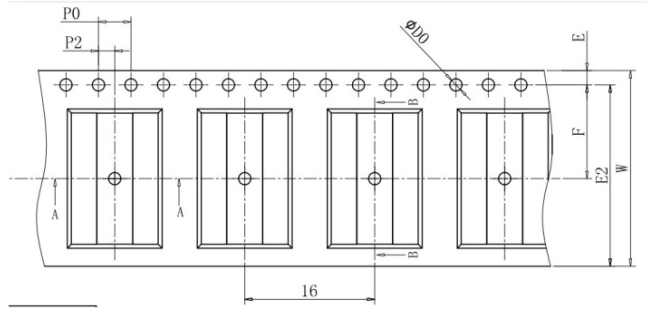

Dimension	E	E2	F	P2	ØD0	ØD1	P0	10P0	W	P	A0	B0	K0	t
Unit(mm)	1.75	22.25	11.5	2.0	1.5		4.0	40	24	16	10.7	16	5.6	0.4

Packing

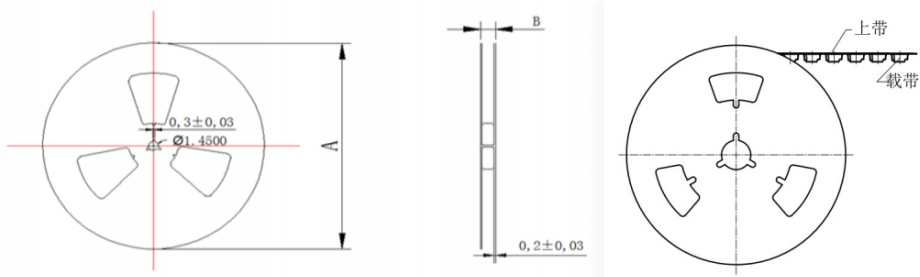

	A(mm)	B(mm)	PCS Per Reel	Inner Box Size (MM)	Box(PCS)	Carton Size (MM)	Carton(PCS)
	330	32	750	340*340*40	750	350*350*360	6000